



























Parts

ITEM	PART #	QTY	DESCRIPTION		ITEM	PART #	QTY	DESCRIPTION	
A	802	1	Tub Track with Vinyl		O	816	2	Towel Bar	
B	814	2	Wall Jamb		P	119	5	#6 x 1/2" Pan Head Screw	
C	113	6	Plastic Wall Anchors		Q	117	2	#10-24 x 7/8" Truss Head Screw	
D	110	6	#8 x 1 1/2" Pan Head Screw		R	118	2	#10-24 x 1 1/8" Flat Head Screw	
E	841	2	Tub Header 7700 / 8700 Series		S	158	4	Towel Bar Trim Rings	
F	131	2	Vinyl Jamb Bumpers		T	138	4	Acrylic Towel Bar Bracket	
G	115	2	#6 x 3/4" Pan Head Screw		U	136	2	Acrylic Finger Pulls	
H	116	4	#6 x 32-3/8" Hex Head Screw		V	820	1	90-Degree Tub Post	
I	130	4	Roller Bearing		W	818	1	180-Degree Tub Post	
J	VM-4	4	Wall Channel Vinyl		X	210	1	Sill	
K	145	1	90-Degree Bracket		Y	137	2	Cover Label	
L	122	4	#6 x 1/4" Phillips Pan MS		Z		1	Glass Panel	
M	148	1	Glass Block		AA		2	Assembled Glass Doors	
N	150	1	Bottom Guide						

Tools

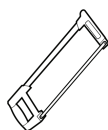

Hacksaw



Philips Screwdriver



Level



3/16" and 1/8" Drill Bit

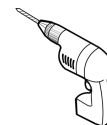

Drill



Tape Measure



Safety Glasses

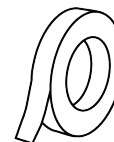

Masking Tape

Installation Notes

- Unpack your unit carefully. Lay out and identify all parts using the instruction sheets as a reference. Before discarding the carton, check for any small hardware bags.
- If any parts are damaged or missing, refer to the description noted in the instructions when contacting your dealer for replacements.
- Please wear safety glasses whenever drilling or cutting.
- Handle the glazed panels carefully; tempered glass is difficult to break, but the sharp corners of the panels can damage tile and floor coverings.
- Before installing, check the tub rim for level and both walls for plumb. If either are out of plumb more than 3/8", you may want to contact your dealer for tapered fillers which can be used to level tub track or plum the side jambs.



Caution: Tempered glass cannot be cut or drilled

1.

MARKING for POSTS

Step 1a.

- Measure from wall to the center of 180-degree post (W) and center of wall jamb (B). This is centerline of enclosure. Plumb the 180-degree post (W) and wall jamb (B) on centerline.
- Mark holes and remove the 180-degree post (W). Drill marked holes with a 3/16" drill bit (for tile or marble use a 3/16" masonry bit).

1a

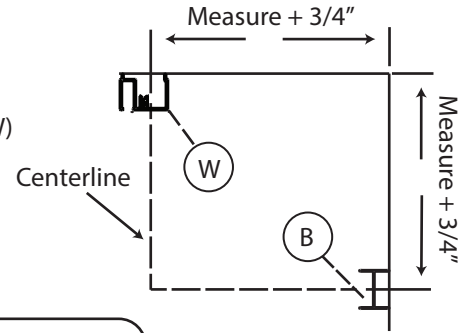

Note: Attachments to fiberglass or acrylic can be made in two ways: if reinforcement is built into the wall of the unit, drill 3 1/8" diameter holes and install the screws directly into the reinforcement.

If wall is not reinforced, drill 3/16" holes and install plastic wall anchors (C).

Step 1b.

- Secure 180-degree post with three #8 X 1 1/2" pan head screws (D).

1b

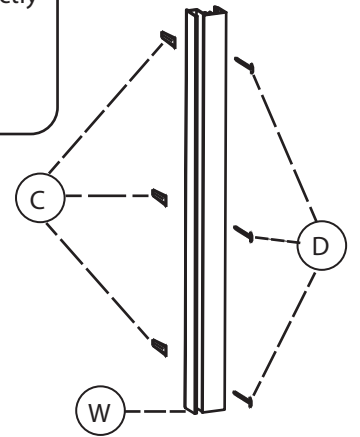

2.

POSITIONING WALL POSTS

Step 2a.

- Insert sill (X) 1/2" into 180-degree post (W).
- Press 90-degree post (V) and attach wall jamb (B) into sill (X) 1/2".
- Make sure 90-degree post and wall is on centerline of enclosure.

2a

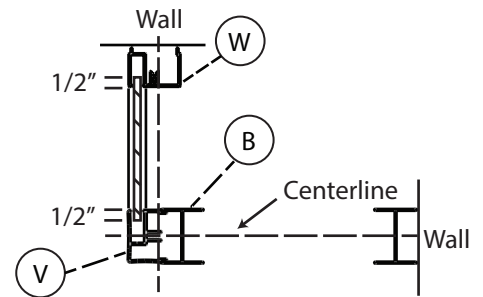

3.

PREPARING the TUB TRACK

Step 3a.

- Measure from wall to outside edge of 90-degree tub post (V).
- Take this measurement and subtract 1 5/8" and cut tub track (A) to that dimension.
- Pull off 90-degree tub post (V) and wall jamb (B). Position the tub track in the center of the tub rim and press it against wall jamb (B) with the tall leg facing the exterior.

3a

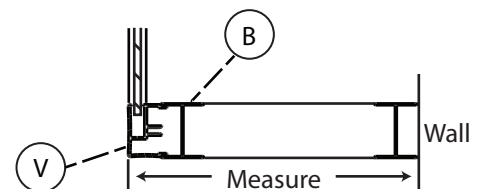

3.

PREPARING the TUB TRACK CONTINUED

Step 3b.

- Press both wall jambs (B) into position over the tub track.
- Masking tape can be used to temporarily hold parts in place.

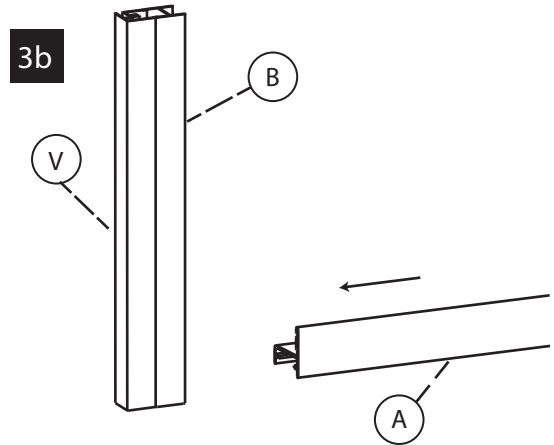

4.

MARKING for WALL JAMB

Step 4a.

- Use a level to plumb both wall jambs (B), then mark the pre-drilled hole locations on the wall.
- Lightly mark along both sides of the tub track (A) with a pencil, then remove all parts. For tile or marble, drill six (3 per wall) 3/16" diameter holes and insert plastic wall anchors (C). A center punch helps locate the holes accurately.

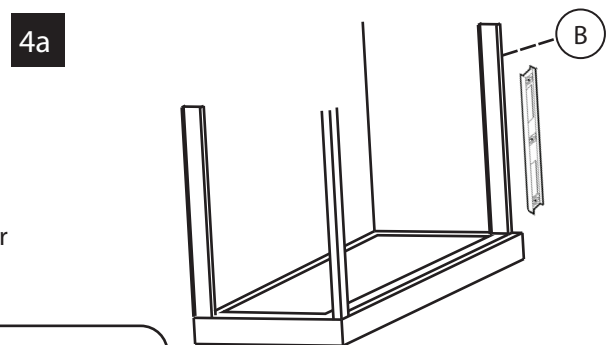

Note: Attachments to fiberglass or acrylic can be made in two ways: if reinforcement is built into the wall of the unit, drill six (3 per wall) 1/8" diameter holes and install the screws directly into the reinforcement.

If wall is not reinforced, drill 3/16" holes and install plastic wall anchors (C).

5.

SECURING the TUB TRACK

Step 5a.

- Before replacing the tub track (A), force a slight downward bow in the extrusion. This will ensure that the track fits tight to the tub.
- Run two beads of silicone inside the penciled mark on the tub rim. Place the tub track in the exact position you marked in step 4a and set it firmly in the silicone.
- Replace wall jamb (B) and attach to wall with #8 X 1 1/2" screws (D). Do not over tighten jamb screws.

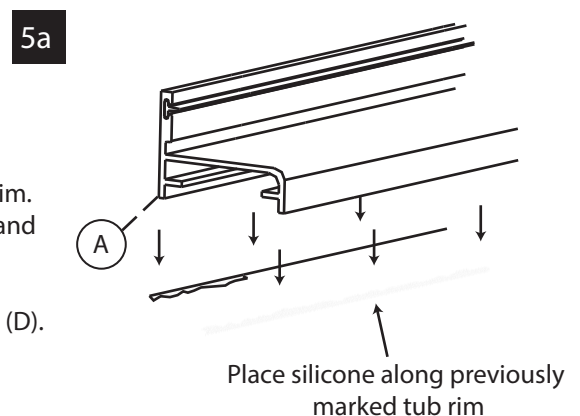

6.

POSITIONING GLASS PANEL

Step 6a.

- Insert sill (X) into 180-degree post (W). Press 90-degree post (V) into sill. Place glass block (M) in the middle of sill (X).
- Position glass panel (Z) so the 180-degree and 90-degree posts overlap glass by 1/2".
- Cut the vinyl slightly longer than the opening to prevent shrinkage.
- Press the interior vinyl into place. Use a wood block to tape the exterior vinyl into place starting at both ends and working towards the middle.

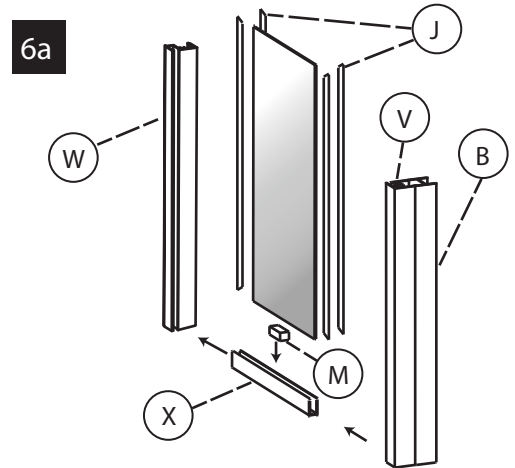

7.

FITTING the TUB HEADER

Step 7a.

- Take measurement and add 1/2" and mark from header (measure from long edge of miter). Cut header then do the same for return header.
- Slide header together with 90-degree bracket (K) and secure with #6 x 1/4" phillips screw (L).
- Place header on unit and from the inside of the enclosure, drill one hole, with a #32 drill bit, through the header and wall jamb on each end of the header.
- Attach the header to the tub jamb using two #6 X 1/2" screws (P).

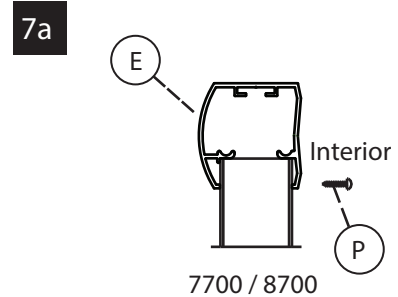

8.

INSTALL the GLASS PANELS

Step 8a.

- To install panels, attach the four nylon roller bearings (I) to the assembled glass door panels (AA) using four #8-32 X 3/8" hex head screws (H) centered in the slots in the top fins.

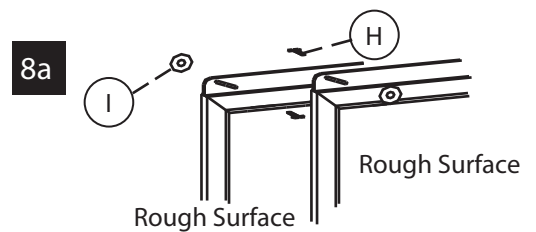

Step 8b.

- To set slider glass in place, hold interior panel inside of tub, insert rollers up into header and lower into roller track.

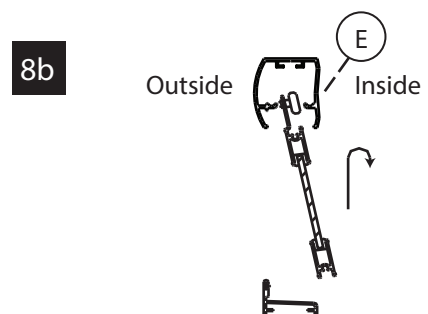

8.

INSTALL the GLASS PANELS CONTINUED

Step 8c.

- Next, insert lower end of exterior slider panel in front of interior slider panel by pushing lower ends far enough in to allow clearance on inside edge of tub. Avoid roller-to-roller contact while lifting panel into place. The inside slider panel will close against wall jamb on showerhead side.

8c

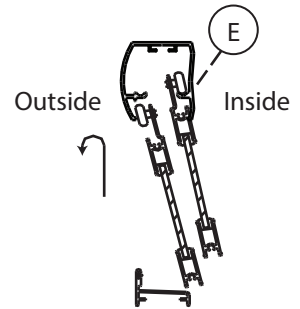

Step 8d.

- Next, push vinyl jamb bumpers (F) into side jambs (B) approximately 1" below center screw.
- Align the slot in the bumper with the outer rail of the slider panel and mark holes through the bumper and drill with #32 drill bit.
- Screw bumper in with #6 X 3/4" pan head screw (G).

8d

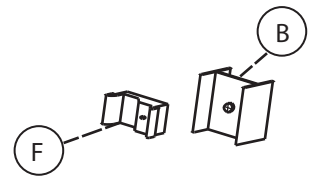

Step 8e.

- Repeat for other side. Do not over tighten. If the door panels are not parallel to their respective wall jambs, remove and adjust rollers up or down in their slots to compensate.

8e

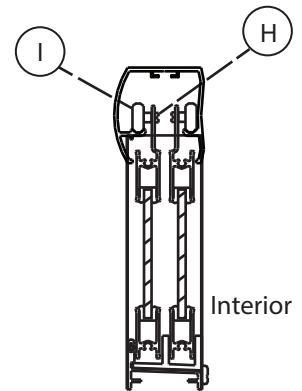

9.

CENTER GUIDE

Step 9a.

- Locate the nylon bottom guide (N) in the center of tub track (A) and place the center guide into place.
- Drill through hole with #32 drill bit, using the factory holes as a template, into track.
- Attach center guide with #6 X 3/8" pan head (P).

9a

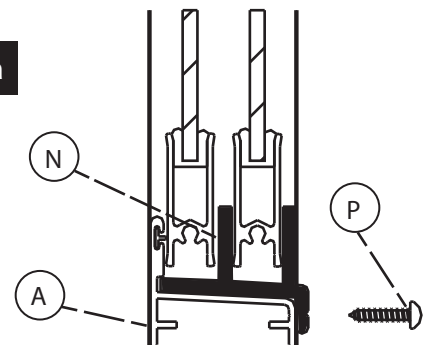

10.

TOWEL BAR

Step 10a.

- Slide the four towel bar trim rings (S) over the acrylic towel bar brackets (T) and press the brackets into the ends of the two towel bars (O).

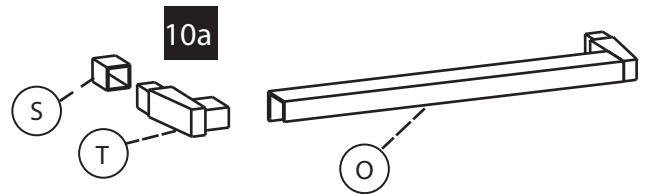

Step 10b.

- Attach a towel bar (with the hollow side of the bar down) to the interior panel with a #10-24 X 7/8" truss head screw (Q) through inner rail.
- Insert a #10-24 X 1 1/8" flat head screw (R) through an acrylic finger pull (U), through the outer rail, and into the outer towel bar bracket.
- Peel the backing from a Splendor cover label (Y), press it into the recess in the acrylic finger pull.
- Repeat for the exterior door panel. **Do not** over tighten the towel bar screws.

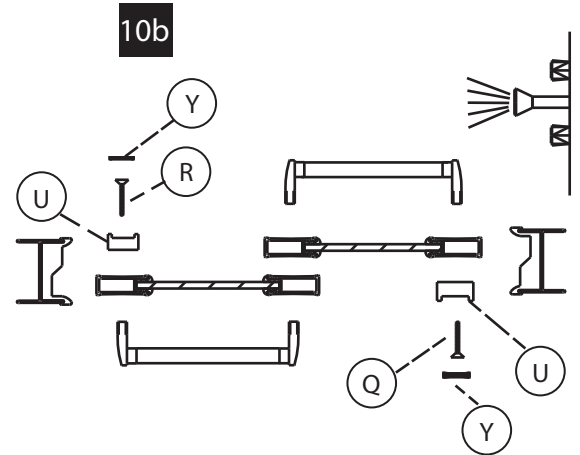

11.

ADDING SILICONE

Step 11a.

- Silicone each end of tub tracks (A) where they meet the wall jambs (B). Run a bead of silicone along interior and exterior edge of track.

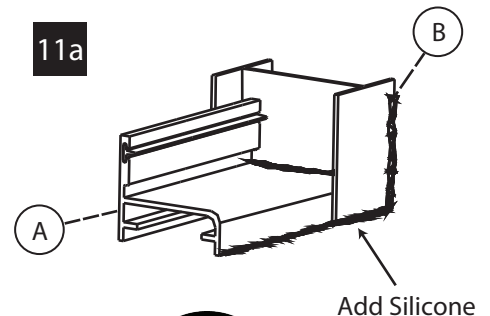

Step 11b.

- We recommend that you let the silicone dry for 24 hours before using the enclosure.

