



















Parts

ITEM	PARTS #	QTY	DESCRIPTION		ITEM	PARTS #	QTY	DESCRIPTION	
A	420	1	Stall Curb		J	VM-3	4	Stall Header and Curb Vinyl	
B	203	2	Wall Channel		K	201	1	Hinge Jamb with Door Attached	
C	113	6	Plastic Wall Anchors		L	202	1	Latch Jamb with Magnet	
D	110	6	#8 x 1 1/2" Pan Head Screw		M	262	1	Magnet Holder with Magnets	
E	147	1	Setting Block		N	119	12	#6 x 1/2" Pan Head Screws	
F		1	Glass Panel		O	402	2	Curb Filler	
G	404	1	180-Degree Post		P	VM-18	1	Handle Vinyl	
H	420	1	Stall Header		Q	VM-12	1	Frameless Dip Bar	
I	VM-4	4	Wall Channel Vinyl		R	EH6X6	1	Handle	

Tools

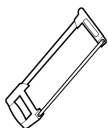

Hacksaw



Philips Screwdriver



Level



3/16" and 1/8" Drill Bit

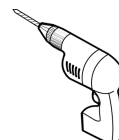

Drill



Safety Glasses



Tape Measure



Masking Tape

Installation Notes

- The order in which the stationary panel and shower door are placed can be reversed. Door can be hinged left or hinge right.
- Unpack your unit carefully. Lay out and identify all parts using the instruction sheets as a reference. Before discarding the carton, check for any small hardware bags.
- If any parts are damaged or missing, refer to the description noted in the instructions when contacting your dealer for replacements.
- Please wear safety glasses whenever drilling or cutting.
- Handle the glazed panels carefully; tempered glass is difficult to break, but the sharp corners of the panels can damage tile and floor coverings.
- Before installing, check the tub rim for level and both walls for plumb. If either are out of plumb more than 3/8", you may want to contact your dealer for tapered fillers which can be used to level tub track or plum the side jambs.



Caution: Tempered glass cannot be cut or drilled

1.

STALL CURB and WALL CHANNEL

Step 1a.

- Measure the opening and cut the stall curb (A) to fit the full width of the opening.
- Position the curb in the center of the opening with the weep slots facing the interior and mark its position.

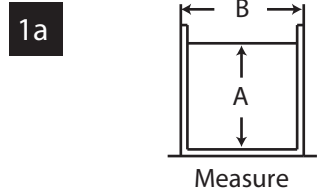

Step 1b.

- Press the wall channels (B) into the curb. Plumb the jambs and mark the hole locations on the wall.
- Remove all parts and drill the wall using 3/16" drill bit. Push the wall anchors (C) into the drilled holes.

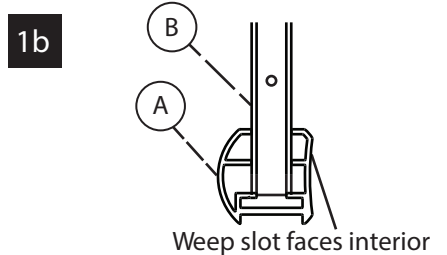

Note: Attachments to fiberglass or acrylic can be made in two ways: if reinforcement is built into the wall of the unit, drill six 1/8" diameter holes and install the screws directly into the reinforcement.

If wall is not reinforced, drill 3/16" holes and install plastic wall anchors (C).

Step 1c.

- Apply silicone to underside of curb (A) and replace the curb back into the previous location. Silicone both ends of curb in the area where it meets the wall.

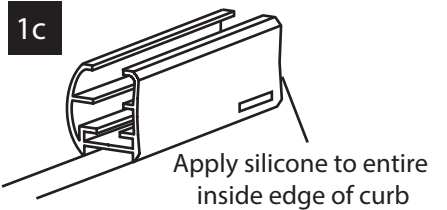

Step 1d.

- Replace wall channels (B) and secure to wall with #8 X 1 1/2" pan head screws (D).

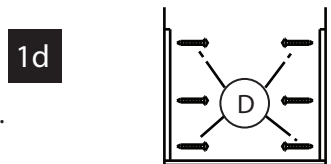

2.

SETTING the GLASS PANEL

Step 2a.

- Determine if panel will be on left or right side of opening.
- Place setting block (E) in the curb (A) as shown. The setting block should be positioned to support glass panel (F) in the middle of panel.
- Set the glass panel so it rests on the setting block and fits approximately 1/2" into the wall channel (B). If obscure glass is used, the rough surface must be turned to the exterior. Glass panel can be placed on the left or right side of unit.
- Press the 180-degree post (G) into the curb (A) and position to overlap glass panel (F) by 1/2".

Note: The 1/2" glass bite may be varied from 1/4" to 3/4" to facilitate for out of plumb walls.

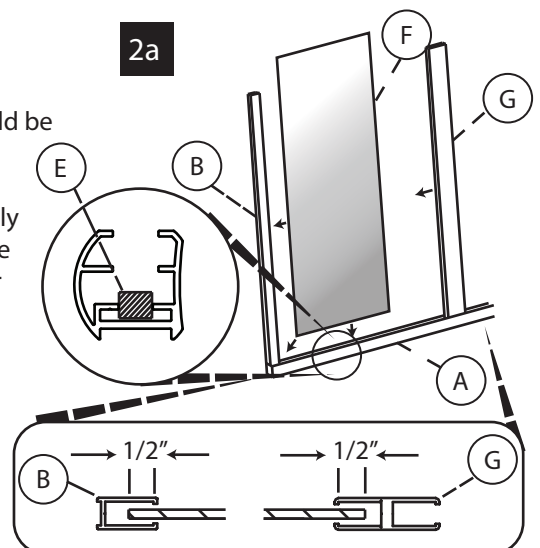

2.

SETTING the GLASS PANEL CONTINUED

Step 2b.

- Measure the wall-to-wall opening at the top of the wall channels (B) and cut the stall header (H) to fit exact opening.
- Place header (H) over wall channels (B) and 180-degree post (G) and secure header to wall channels by drilling holes with a 1/8" drill bit through header and wall channels from inside of shower.
- Slide glass panel (F) away from the wall channels before drilling. The drill bit must not hit the glass.
- Secure with #6 X 1/2" pan head screws (N). Repeat on other side and bottom two corners. Reposition the glass panel.

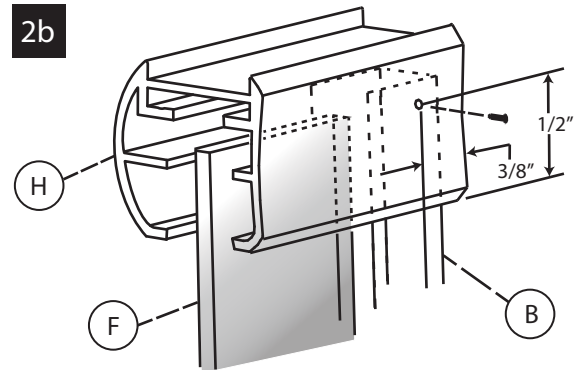

3.

DOOR and PANEL

Note: For the door and panel to fit the opening, the unit has a 1" adjustment in the fixed panel and a 1" adjustment in the door; 1/2" maximum adjustment at each end. Most installers prefer to take the maximum amount of adjustment out of the fixed panel.

To determine these adjustments: the glass of the fixed panels must go into the wall channel (B) and 180 degree post (G) at least 1/4" on both sides; this is to ensure that the vinyl will hold the glass properly and provide adequate water protection.

The distance between the wall channel and 180-degree post on the fixed panel side can never be smaller than the panel size minus 1 1/2" and never wider than the panel size minus 1/2" (For example: A 10" panel equals 8 1/2" minimum distance and 9 1/2" maximum distance). Next, the opening for the door must be large enough.

Step 3a.

- Measure the door panel width (see below). The top and bottom door rails must be equal.
- Measure the distance between the wall channel (B) and the 180-degree post (G). This measurement between posts must be a 1/2" greater than the door panel width, and no more than 1 1/2" longer than the door panel width.
- Next, secure stall header (H) and stall curb (A) to 180-degree post (G) by drilling 1/8" holes and attach with #6 x 1/2" pan head screws (N).

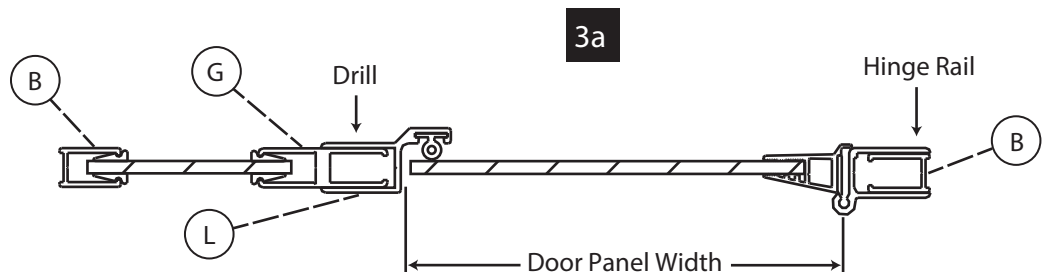

3.

DOOR and PANEL CONTINUED

Step 3b.

- Determine the direction your door will swing. Set the latch jamb over the post (magnet facing the outside), but do not secure.

- From inside of shower, set the hinge jamb (with door attached) in place over the post (G). Close the door so door magnet and latch jamb magnet connects. Adjust door on wall channel (B) and 180-degree post (G).

- Next, drill through to the pilot hole of hinge jamb into post using 1/8" drill bit. Secure top hole using a #6 X 1/2" screw (N). The door will hold in place with only top screw.

- Plumb hinge jamb and drill and secure the other five holes.

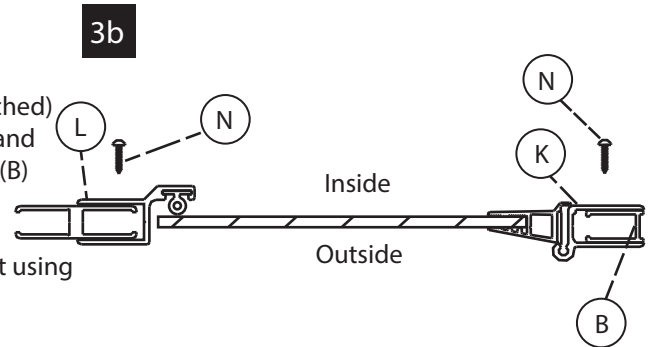

4.

MEASURE for CURB FILLERS

Step 4a.

- Measure between the latch jamb (L) and the hinge jamb (K). Cut curb fillers to this measurement.

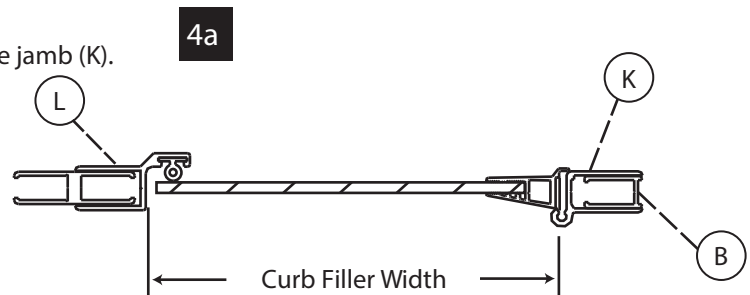

Step 4b.

- Snap curb fillers (O) into stall header (H) and stall curb (A) with the 1/8" lip to the outside.

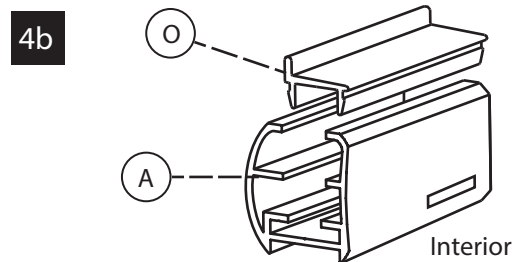

5.

HANDLE ATTACHMENT

Step 5a.

- The vinyl on the latch jamb has a notch; the magnet holder with magnet will be placed on glass and shut on notch.
- Wrap handle vinyl (P) around edge of glass, push magnet hold on vinyl. This goes on hard so there is no movement. May have to pound with mallet.
- Make sure the magnet catch on the magnet holder in on inside of the shower. Shut door to make sure magnets are touching.

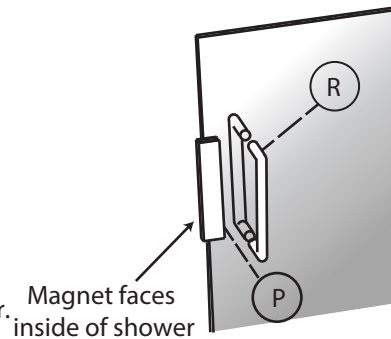

- Add handle through holes in glass. Set screws should be on the inside.

6.

APPLYING the VINYL STRIP

Step 6a.

- Inspect the glazing vinyl and note that there are two profiles. The larger profile (J) is installed horizontally and the smaller profile (I) is installed vertically. The horizontal vinyl is installed first.
- Cut the vinyl slightly longer than the opening (this prevents shrinkage). Press the interior vinyl into place.
- Use a wood block to tap the exterior vinyl into place starting at both ends and work towards the middle.
- Install the bottom vinyl in the same manner.
- Install the vertical vinyl being sure the corners fit tightly against the horizontal vinyl. If vinyl is difficult to tap on, lubricate the glass and vinyl with glass cleaner, then press on vinyl.

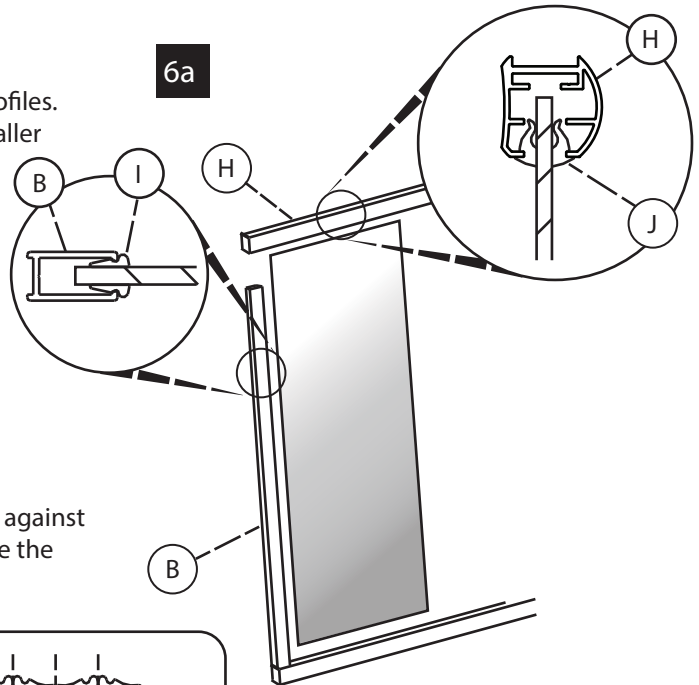

Note: The wall channel vinyl (I) may be provided with four strips in one. Tear each strip off.

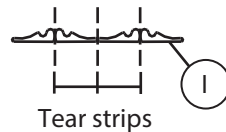

7.

DRIP BAR

Step 7a.

- Take vinyl drip bar (Q). Note that there is a notch on both ends. Measure exposed glass at bottom of door. Cut vinyl (Q) 1/2" less than exposed glass.
- If door is hinge right, leave right side notch, opposite for a hinge left. Notch part of vinyl slides under rail that is attached to glass. Push up on glass, making sure lip on vinyl faces inside.

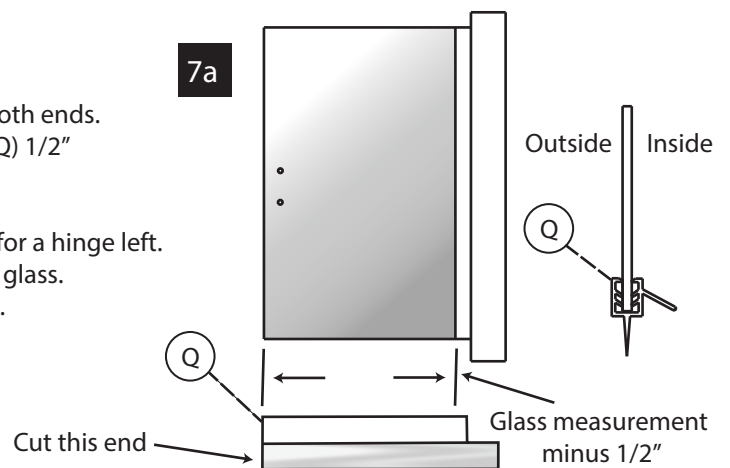

8.

SILICONE SETUP

Step 8a.

- Silicone the entire unit where metal meets wall and curb. We recommend you let silicone set for 24 hours before using shower

