

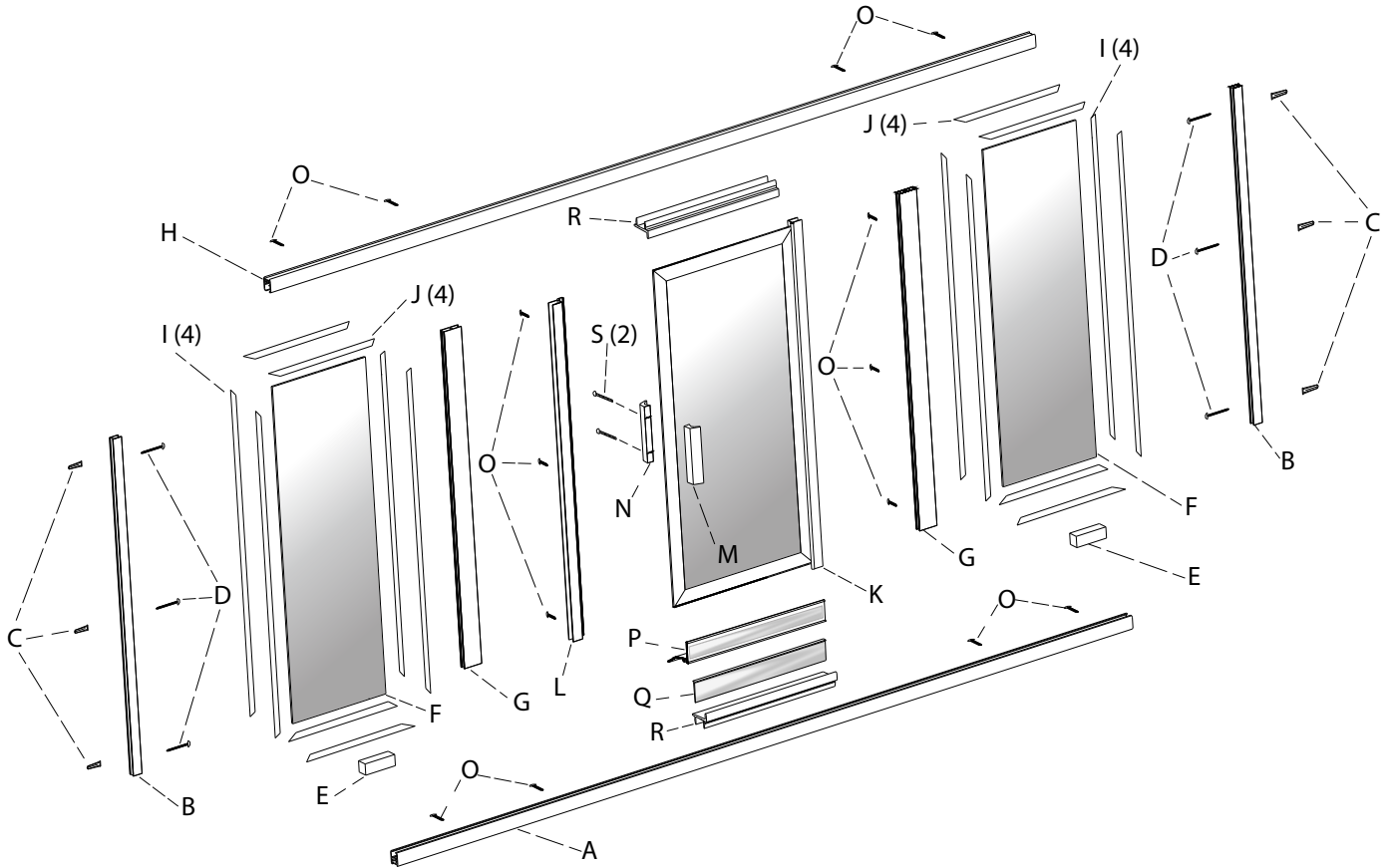



















# Installation Instructions

Premier Series 1250

Deluxe Series 1350



## Parts

ITEM	PART #	QTY	DESCRIPTION		ITEM	PART #	QTY	DESCRIPTION	
A	401 C	1	Stall Curb		K	201	1	Hinge Jamb with Door Attached	
B	203	2	Wall Channel		L	202	1	Latch Jamb with Magnet	
C	113	6	Plastic Wall Anchors		M	214 F	1	Exterior Handle	
D	110	6	#8 x 1 1/2" Pan Head Screw		N	214 M	1	Interior Handle	
E	147	2	Setting Block		O	119	14	#6 x 1/2" Pan Head Screws	
F		2	Glass Panel		P	204	1	Drip Bar with Tape	
G	404	2	180-Degree Post		Q	VM-2	1	Drip Bar Vinyl	
H	401 H	1	Stall Header		R	402	2	Curb Fillers	
I	VM-4	8	Wall Channel Vinyl		S	114	2	#6-32 X 1 1/4" Round Head Screws	
J	VM-3	8	Stall Header and Curb Vinyl						

## Tools

---

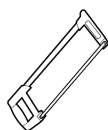

Hacksaw



Philips Screwdriver

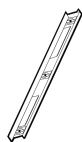

Level



3/16" and 1/8" Drill Bit



Drill



Tape Measure



Safety Glasses



Masking Tape

## Installation Notes

---

- The order in which the stationary panel and shower door are placed can be reversed.
- Unpack your unit carefully. Lay out and identify all parts using the instruction sheets as a reference. Before discarding the carton, check for any small hardware bags.
- If any parts are damaged or missing, refer to the description noted in the instructions when contacting your dealer for replacements.
- Please wear safety glasses whenever drilling or cutting.
- Handle the glazed panels carefully; tempered glass is difficult to break, but the sharp corners of the panels can damage tile and floor coverings.



**Caution: Tempered glass cannot be cut or drilled**

# 1.

## STALL CURB and WALL CHANNEL

### Step 1a.

- Measure the opening and cut the stall curb (A) to fit the full width of the opening. Position the curb in the center of the opening with the weep slots facing the interior and mark its position.

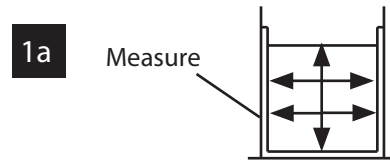

### Step 1b.

- Press the wall channels (B) into the curb. Plumb the wall channels (B) and mark the hole locations on the wall.
- Remove all parts and drill the wall for plastic wall anchors using 3/16" drill bit. Push the wall anchors (C) into the drilled holes.

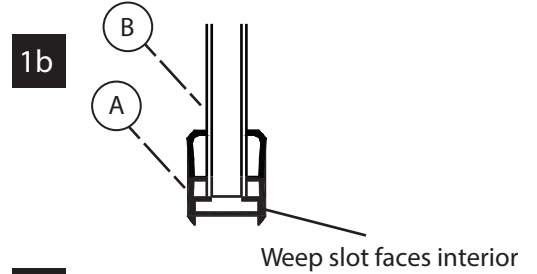

### Step 1c.

- Apply silicone to underside of curb (A) and replace the curb in previous location. Silicone both ends of curb where it meets the wall.

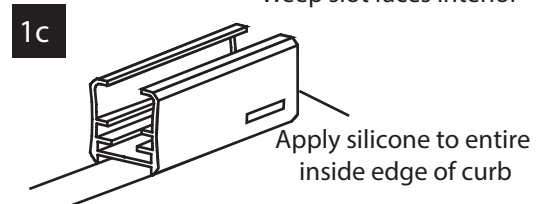

### Step 1d.

- Replace wall channels (B) and secure to wall with six #8 X 1 1/2" pan head screws (D).

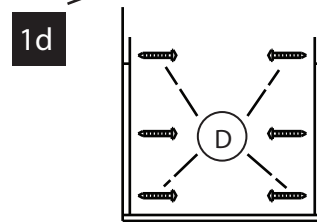

# 2.

## SETTING the GLASS PANELS

### Step 2a.

- Place setting block (E) in the curb (A) as shown. The setting block should be positioned to support glass panel (F) in the middle of panel.
- Set the glass panel so it rests on the setting block and fits approximately 1/2" into the wall channel (B). If obscure glass is used, the rough surface must be turned to the exterior.
- Press the 180-degree post (G) into the curb (A) and position to overlap glass panel (F) by 1/2".

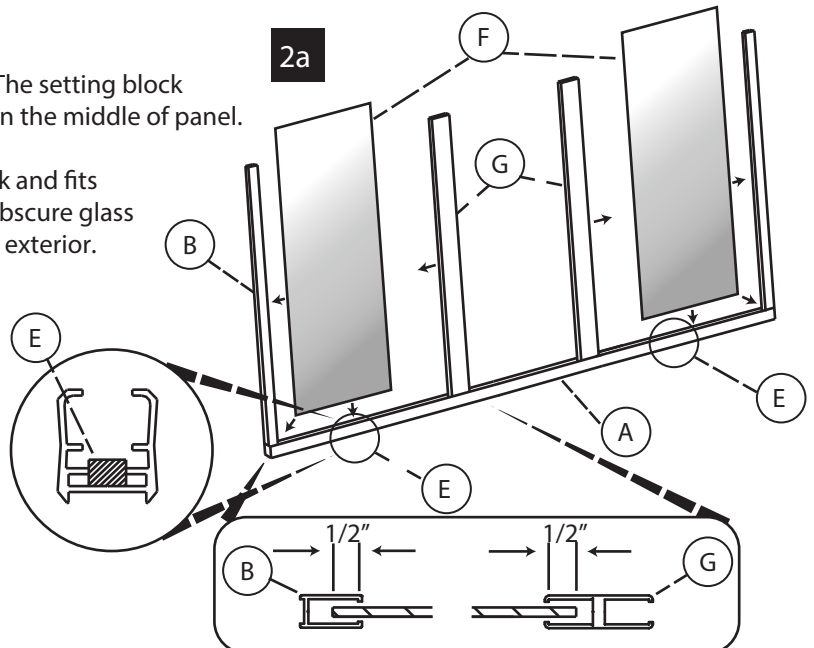

## 2.

### SETTING the GLASS PANELS CONTINUED

#### Step 2b.

- Measure the wall-to-wall opening at the top of the wall channel and cut the header (H) to fit exact opening.
- Place header (H) over wall channels (B) and 180-degree post (G) and secure header to wall channels by drilling holes with a 1/8" drill bit through header and wall channels from inside of shower.
- Slide glass panel (F) away from the wall channels before drilling. The drill bit must not hit the glass.
- Secure with #6 X 1/2" pan head screws (O). Repeat on other side and bottom two corners. Reposition the glass panel.

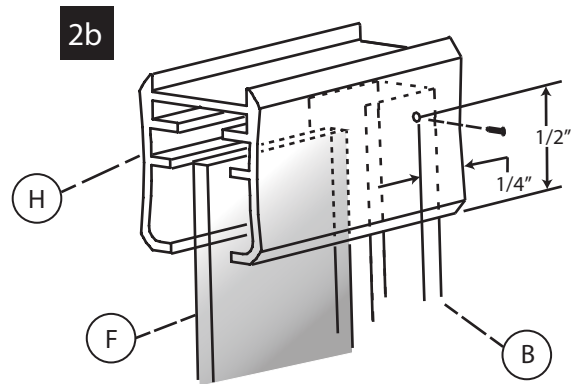

## 3.

### DOOR and PANEL

**Note:** For the door and panel to fit the opening, the unit has a 1" adjustment in the fixed panel and a 1" adjustment in the door; 1/2" maximum adjustment at each end. Most installers prefer to take the maximum amount of adjustment out of the fixed panel.

To determine these adjustments: the glass of the fixed panels must go into the wall channel (B) and 180 degree post (G) at least 1/4" on both sides; this is to ensure that the vinyl will hold the glass properly and provide adequate water protection.

The distance between the wall channel and 180-degree post on the fixed panel side can never be smaller than the panel size minus 1 1/2" and never wider than the panel size minus 1/2" (For example: A 10" panel equals 8 1/2" minimum distance and 9 1/2" maximum distance). Next, the opening for the door must be large enough.

#### Step 3a.

- Measure the door panel width. The top and bottom door rails must be equal.
- Measure the distance between the wall channel (B) and the 180-degree post (G). This measurement between posts must be a 1/2" greater than the door panel width, and no more than 1 1/2" longer than the door panel width.
- Next, secure stall header (H) and stall curb (A) to 180-degree post (G) by drilling 1/8" holes and attach with #6 x 1/2" pan head screws (O).

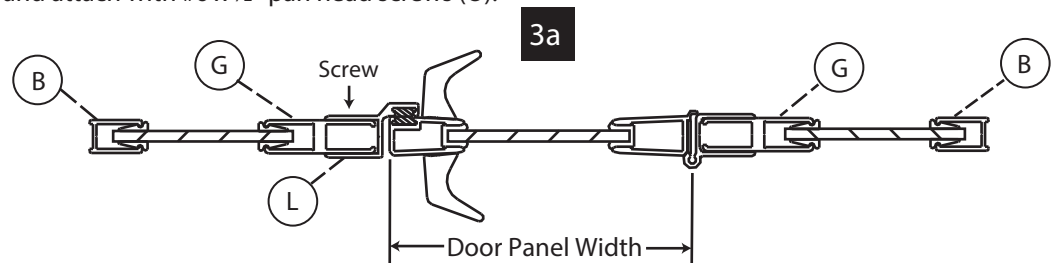

### 3.

#### DOOR and PANEL CONTINUED

##### Step 3b.

- Determine the direction your door will swing. Set the latch jamb (L) over the post with magnet facing the outside, but do not secure.
- From inside of shower, set the hinge jamb (K) in place over the 180-degree post (G). Close the door so the magnet and latch jamb magnet connects. Adjust the door on wall channel (B) and 180-degree post (G).
- Next, drill through top pilot hole of hinge jamb into post using 1/8" drill bit. Secure top hole using #6 X 3/8" screw (O); the door will stay in place with only top screw.
- Plumb hinge jamb and drill the other five holes and secure with the rest of the screws.

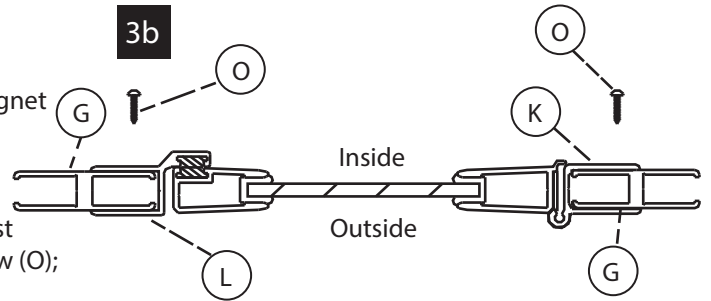

### 4.

#### MEASURE for CURB FILLERS

##### Step 4a.

- Measure between the latch jamb (L) and the hinge jamb (K). Cut curb fillers to this measurement.

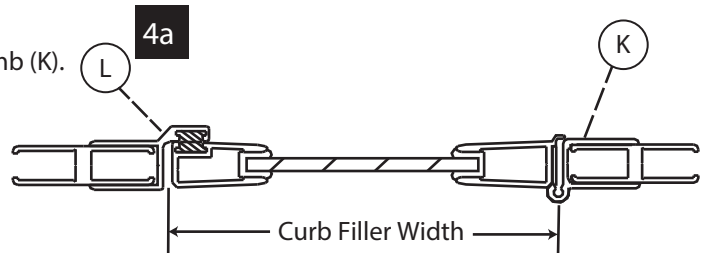

##### Step 4b.

- Snap curb fillers into stall header (H) and stall curb (A) with the 1/8" lip facing outwards.

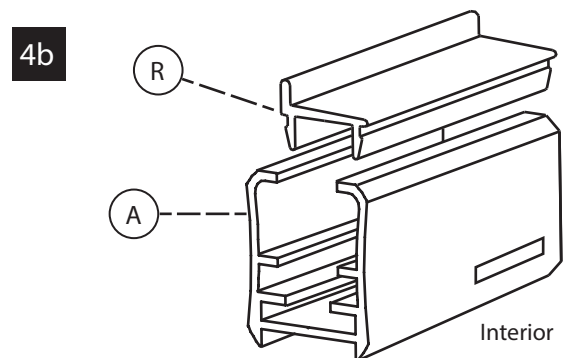

### 5.

#### HANDLE ATTACHMENT

##### Step 5a.

- Attach the exterior handle (M) and the interior handle (N) to the door with two # 6-32 X 1 1/4" round head screws (S).

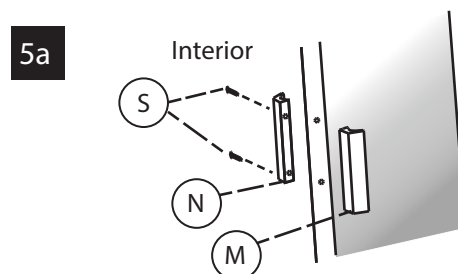

## 6.

### APPLYING the VINYL STRIP

#### Step 6a.

- Inspect the glazing vinyl and note that there are two profiles. The larger profile (J) is installed horizontally and the smaller profile (I) is installed vertically. The horizontal vinyl is installed first.
- Cut the vinyl slightly longer than the opening (this prevents shrinkage). Press the interior vinyl into place.
- Use a wood block to tap the exterior vinyl into place starting at both ends and work towards the middle.
- Install the bottom vinyl in the same manner.
- Install the vertical vinyl being sure the corners fit tightly against the horizontal vinyl. If vinyl is difficult to tap on, lubricate the glass and vinyl with glass cleaner, then press on vinyl.

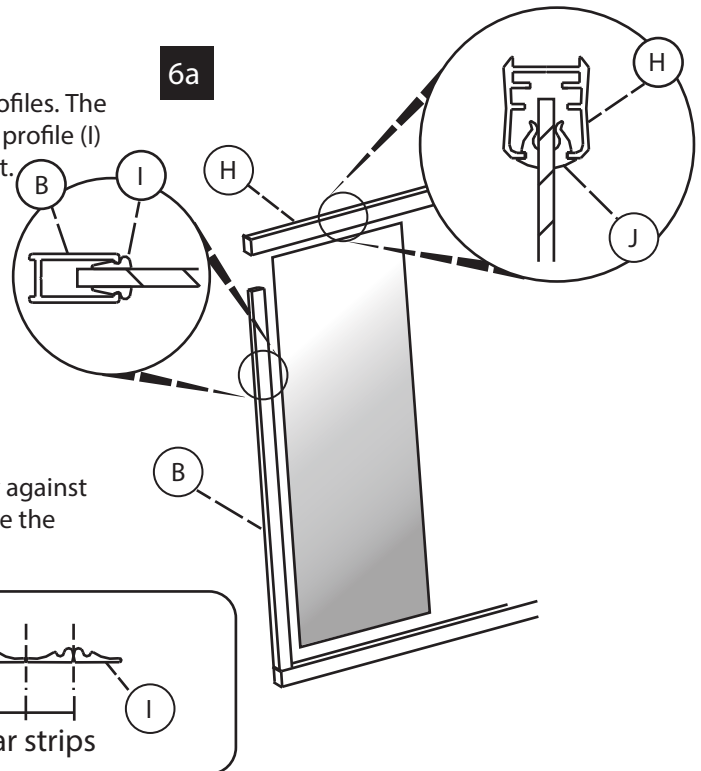

## 7.

### DRIP BAR

#### Step 7a.

- Next take the drip bar with tape (P) and the clear drip bar vinyl (Q). Slide the vinyl into the groove at the bottom of the drip bar.
- Leave 1/4" hanging out at both ends and crimp, so that the vinyl does not move.

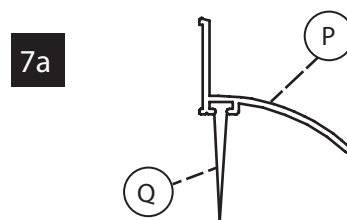

#### Step 7b.

- From inside of shower, set drip bar on bottom rail and adjust so approximately 1/8" daylight space remains between bottom of vinyl and curb filler (R).
- Mark with pencil; peel off tape and press drip bar to door on marked position. You only get one chance to do this; **the adhesive is permanent.**

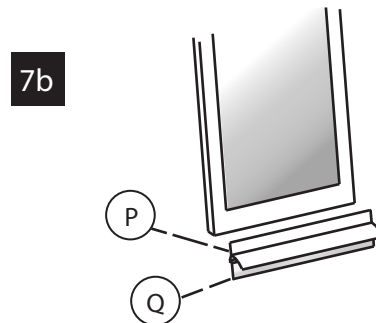

## 8.

### SILICONE SETUP

#### Step 8a.

- Silicone the entire unit where metal meets wall and curb. We recommend you let silicone set for 24 hours before using shower



24hrs